

This section includes miscellaneous casework components to be used in conjunction with our three lines of cabinets:

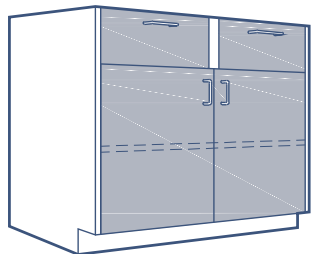

Forte Inset

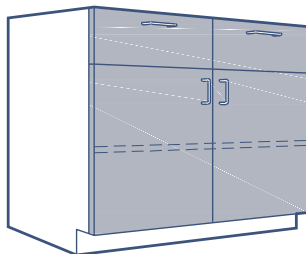

Forte Flush Overlay

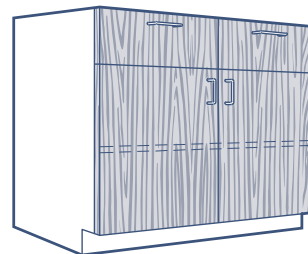

Harmony

- ▶ **Base cabinet fillers and kneeholes**
- ▶ **Bench legs and supports**
- ▶ **Shelving supports and shelves**
- ▶ **Back panels**
- ▶ **Wall cabinet filler panels**
- ▶ **Reagent racks and cylinder racks**
- ▶ **Umbilical chases**
- ▶ **Overhead service carriers**

Pages 2 and 3

Pages 4 and 5

Pages 6, 10 and 11

Page 7

Pages 8 and 9

Pages 12 and 13

Page 14

Page 15

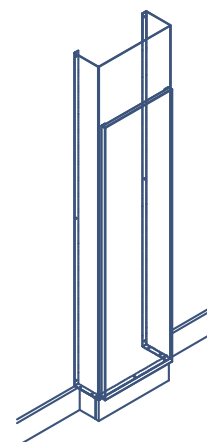
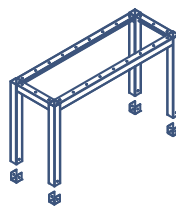
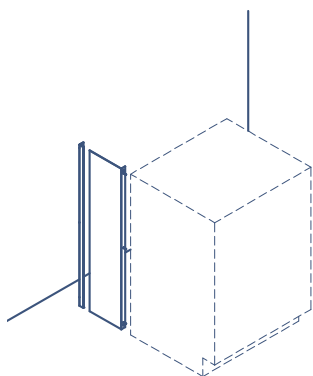

Base cabinet fillers

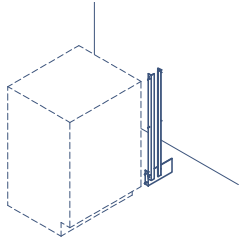
**Short front filler** - to fill the space between a cabinet and the adjacent wall

Standing height benches			Sitting height benches			ADA height benches		
Model no.	Width	Height	Model no.	Width	Height	Model no.	Width	Height
AFFP-1	1"	34,75"	BFFP-1	1"	28,75"	ADA-FFP-1	1"	32,5"
AFFP-2	2"	34,75"	BFFP-2	2"	28,75"	ADA-FFP-2	2"	32,5"

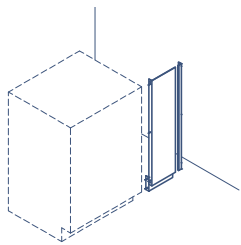
**Front filler** - to fill the space between cabinets or between a cabinet and the adjacent wall

Standing height benches			Sitting height benches			ADA height benches		
Model no.	Width	Height	Model no.	Width	Height	Model no.	Width	Height
AFFP-6	6"	34,75"	BFFP-6	6"	28,75"	ADA-FFP-6	6"	32,5"
AFFP-12	12"	34,75"	BFFP-12	12"	28,75"	ADA-FFP-12	12"	32,5"
AFFP-24	24"	34,75"	BFFP-24	24"	28,75"	ADA-FFP-24	24"	32,5"
AFFP-30	30"	34,75"	BFFP-30	30"	28,75"	ADA-FFP-30	30"	32,5"

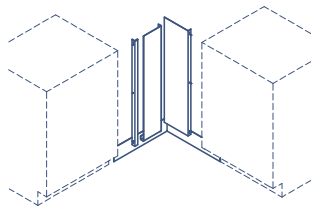
**Corner filler** - to fill the space between cabinets in bench inside corners wall

Standing height benches			Sitting height benches			ADA height benches		
Model no.	Width	Height	Model no.	Width	Height	Model no.	Width	Height
ACFP-1	1"	34,75"	BCFP-1	1"	28,75"	ADA-CFP-1	1"	32,5"
ACFP-6	6"	34,75"	BCFP-6	6"	28,75"	ADA-CFP-6	6"	32,5"
ACFP-12	12"	34,75"	BCFP-12	12"	28,75"	ADA-CFP-12	12"	32,5"
ACFP-24	24"	34,75"	BCFP-24	24"	28,75"	ADA-CFP-24	24"	32,5"

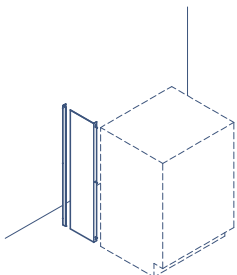
**End filler** - to fill the space between the cabinet back and the back wall

Standing height benches			Sitting height benches			ADA height benches		
Model no.	Width	Height	Model no.	Width	Height	Model no.	Width	Height
AAFP-2	2"	34,75"	BEFP-2	2"	28,75"	ADA-AFP-2	2"	32,5"
AAFP-8	8"	34,75"	BEFP-8	8"	28,75"	ADA-AFP-8	8"	32,5"
AAFP-13	13"	34,75"	BEFP-13	13"	28,75"	ADA-AFP-13	13"	32,5"
AAFP-16	16"	34,75"	BEFP-16	16"	28,75"	ADA-AFP-16	16"	32,5"

Slim kneehole apron assemblies - made to support suspended cabinets between various bench support legs (shown on pages 6 & 7)

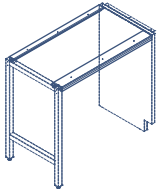

Model no.	Width	Height	Model no.	Width	Height
A45-18	18"	1 1/4"	A45-42	42"	1 1/4"
A45-24	24"	1 1/4"	A45-48	48"	1 1/4"
A45-30	30"	1 1/4"	A45-60	60"	1 1/4"
A45-36	36"	1 1/4"	A45-72	72"	1 1/4"

Kneehole apron - to support the counter top between cabinets or between a cabinet and the adjacent wall

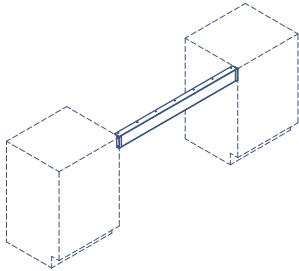

Model no.	Width	Height	Model no.	Width	Height
B48-24	24"	2"	A48-24	24"	4"
B48-30	30"	2"	A48-30	30"	4"
B48-36	36"	2"	A48-36	36"	4"
B48-42	42"	2"	A48-42	42"	4"
B48-48	48"	2"	A48-48	48"	4"
B48-60	60"	2"	A48-60	60"	4"
B48-72	72"	2"	A48-72	72"	4"

Kneehole 1-drawer structures - to support the counter top between cabinets or between a cabinet and the adjacent wall with an 18" wide drawer

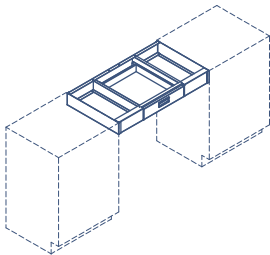

21" depth assemblies			28" depth assemblies		
Model no.	Width	Height	Model no.	Width	Height
A46-24-21	24"	4"	A46-24-28	24"	4"
A46-30-21	30"	4"	A46-30-28	30"	4"
A46-36-21	36"	4"	A46-36-28	36"	4"
A46-42-21	42"	4"	A46-42-28	42"	4"
A46-48-21	48"	4"	A46-48-28	48"	4"
A46-60-21	60"	4"	A46-60-28	60"	4"
A46-72-21	72"	4"	A46-72-28	72"	4"

Kneehole 2-drawer structures - to support the counter top between cabinets or between a cabinet and the adjacent wall with 2 x 18" wide drawers

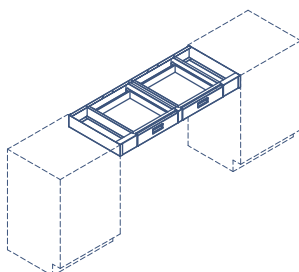

21" depth assemblies			28" depth assemblies		
Model no.	Width	Height	Model no.	Width	Height
A47-48-21	48"	4"	A47-48-28	48"	4"
A47-60-21	60"	4"	A47-60-28	60"	4"
A47-72-21	72"	4"	A47-72-28	72"	4"

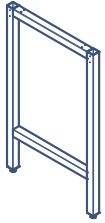

"H" leg supports

21" depth leg assemblies			28" depth leg assemblies		
Model no.	Depth	Height	Model no.	Depth	Height
B50-21	21"	28,75"	B50-28	28"	28,75"
ADA50-21	21"	32,5"	ADA50-28	28"	32,5"
A50-21	21"	34,75"	A50-28	28"	34,75"



Gables

21" depth gables			29" depth gables		
Model no.	Depth	Height	Model no.	Depth	Height
B51-21	21"	28,75"	B51-29	29"	28,75"
ADA51-21	21"	32,5"	ADA-51-29	29"	32,5"
A51-21	21"	34,75"	A51-29	29"	34,75"

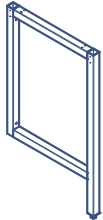

"P" leg supports

21" depth leg assemblies			29" depth leg assemblies		
Model no.	Depth	Height	Model no.	Depth	Height
BPL-21	21"	28,75"	BPL-29	29"	28,75"
ADA-PL-21	21"	32,5"	ADA-PL-29	29"	32,5"
APL-21	21"	34,75"	APL-29	29"	34,75"

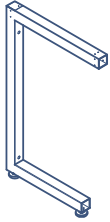

“C” bench supports

21" depth leg assemblies			29" depth leg assemblies		
Model no.	Depth	Height	Model no.	Depth	Height
BCL-21	21"	28,75"	BCL-29	29"	28,75"
ADA-CL-21	21"	32,5"	ADA-CL-29	29"	32,5"
ACL-21	21"	34,75"	ACL-29	29"	34,75"

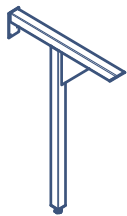

“T” bench supports

23" depth leg assemblies			29" depth leg assemblies		
Model no.	Depth	Height	Model no.	Depth	Height
BTL-23	23"	28,75"	BTL-29	29"	28,75"
ADA-TL-23	23"	32,5"	ADA-TL-29	29"	32,5"
ATL-23	23"	34,75"	ATL-29	29"	34,75"

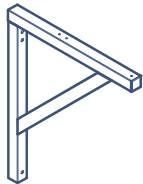

“L” bench supports

23" depth leg assemblies			29" depth leg assemblies		
Model no.	Depth	Height	Model no.	Depth	Height
BLL-23	23"	23"	BLL-29	29"	29"



Pipe supports - for plumbing service support in service areas between walls and cabinets

Wall bench pipe supports			Island bench pipe supports		
Model no.	Depth	Height	Model no.	Depth	Height
B-WPS-8	8"	28,75"	B-WPS-16	16"	28,75"
ADA-WPS-8	8"	32,5"	ADA-WPS-16	16"	32,5"
A-WPS-8	8"	34,75"	A-WPS-16	16"	34,75"



Single wall shelving standards - shelves adjustment in 1" increments

Double slotted standards			
Model no.	Width	Depth	Height
WST2-36	1,5"	0,75"	36"
WST2-48	1,5"	0,75"	48"
WST2-84	1,5"	0,75"	84"

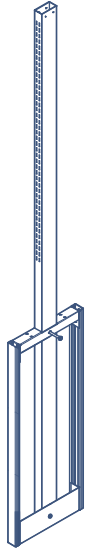

Island shelving post structure - made with 1,5" x 3" tube and double slotted on both sides for shelf adjustment in 1" increments

60" high post structure				84" high post structure			
Model no.	Width	Post depth	Structure depth	Model no.	Width	Post depth	Structure depth
ISP1-60	1,5"	3"	16"	ISP1-84	1,5"	3"	16"
ISP2-60	1,5"	3"	28"	ISP2-84	1,5"	3"	28"



Island shelving structure - all-welded structure fixed over the counter top and double slotted on both sides for shelf adjustment in 1" increments

48" high upright				60" high upright			
Model no.	Width	Height	Structure depth	Model no.	Width	Height	Structure depth
ISS1-48	1,5"	48"	12"	ISS1-60	1,5"	60"	12"

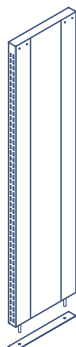

Island shelving structure - service upright fixed over the counter top and double slotted on both sides for shelf adjustment in 1" increments with service panel insert on both sides

48" high upright				60" high upright			
Model no.	Width	Height	Structure depth	Model no.	Width	Height	Structure depth
ISS2-48	1,5"	48"	12"	ISS2-60	1,5"	60"	12"

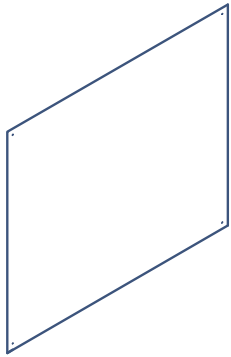

Base cabinet flat finished backs

Standing height benches			Sitting height benches			ADA height benches		
Model no.	Width	Height	Model no.	Width	Height	Model no.	Width	Height
AB0-24	24"	34,75"	BB0-24	24"	28,75"	ADA-B0-24	24"	32,5"
AB0-30	30"	34,75"	BB0-30	30"	28,75"	ADA-B0-30	30"	32,5"
AB0-36	36"	34,75"	BB0-36	36"	28,75"	ADA-B0-36	36"	32,5"
AB0-42	42"	34,75"	BB0-42	42"	28,75"	ADA-B0-42	42"	32,5"
AB0-48	48"	34,75"	BB0-48	48"	28,75"	ADA-B0-48	48"	32,5"
AB0-60	60"	34,75"	BB0-60	60"	28,75"	ADA-B0-60	60"	32,5"
AB0-72	72"	34,75"	BB0-72	72"	28,75"	ADA-B0-72	72"	32,5"

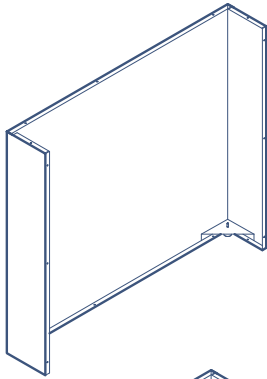

Base cabinet 7" extended finished backs

Standing height benches			Sitting height benches			ADA height benches		
Model no.	Width	Height	Model no.	Width	Height	Model no.	Width	Height
AB6-24	24"	34,75"	BB6-24	24"	28,75"	ADA-B6-24	24"	32,5"
AB6-30	30"	34,75"	BB6-30	30"	28,75"	ADA-B6-30	30"	32,5"
AB6-36	36"	34,75"	BB6-36	36"	28,75"	ADA-B6-36	36"	32,5"
AB6-42	42"	34,75"	BB6-42	42"	28,75"	ADA-B6-42	42"	32,5"
AB6-48	48"	34,75"	BB6-48	48"	28,75"	ADA-B6-48	48"	32,5"
AB6-60	60"	34,75"	BB6-60	60"	28,75"	ADA-B6-60	60"	32,5"
AB6-72	72"	34,75"	BB6-72	72"	28,75"	ADA-B6-72	72"	32,5"

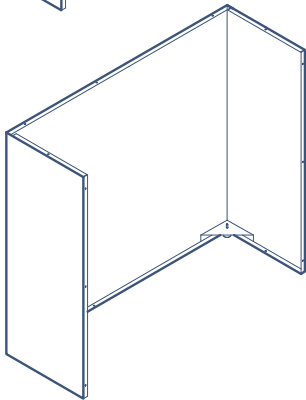

Base cabinet 13" extended finished backs

Standing height benches			Sitting height benches			ADA height benches		
Model no.	Width	Height	Model no.	Width	Height	Model no.	Width	Height
AB12-24	24"	34,75"	BB12-24	24"	28,75"	ADA-B12-24	24"	32,5"
AB12-30	30"	34,75"	BB12-30	30"	28,75"	ADA-B12-30	30"	32,5"
AB12-36	36"	34,75"	BB12-36	36"	28,75"	ADA-B12-36	36"	32,5"
AB12-42	42"	34,75"	BB12-42	42"	28,75"	ADA-B12-42	42"	32,5"
AB12-48	48"	34,75"	BB12-48	48"	28,75"	ADA-B12-48	48"	32,5"
AB12-60	60"	34,75"	BB12-60	60"	28,75"	ADA-B12-60	60"	32,5"
AB12-72	72"	34,75"	BB12-72	72"	28,75"	ADA-B12-72	72"	32,5"

Service cover panel - to close the kneehole back space between cabinets

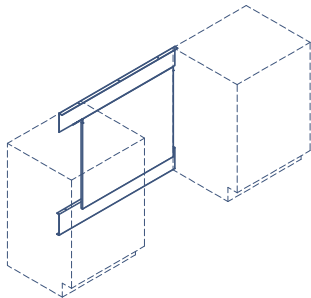

Standing height benches			Sitting height benches			ADA height benches		
Model no.	Width	Height	Model no.	Width	Height	Model no.	Width	Height
A49-24	24"	34,75"	B49-24	24"	28,75"	ADA-49-24	24"	32,5"
A49-30	30"	34,75"	B49-30	30"	28,75"	ADA-49-30	30"	32,5"
A49-36	36"	34,75"	B49-36	36"	28,75"	ADA-49-36	36"	32,5"
A49-42	42"	34,75"	B49-42	42"	28,75"	ADA-49-42	42"	32,5"
A49-48	48"	34,75"	B49-48	48"	28,75"	ADA-49-48	48"	32,5"
A49-60	60"	34,75"	B49-60	60"	28,75"	ADA-49-60	60"	32,5"
A49-72	72"	34,75"	B49-72	72"	28,75"	ADA-49-72	72"	32,5"
A49-P	6"	34,75"	B49-P	6"	28,75"	ADA-49-P	6"	32,5"

Support angles



Sitting height benches		
Model no.	Angle sizes	Width
AA-48	2" x 2"	48"
AA-96	2" x 2"	96"

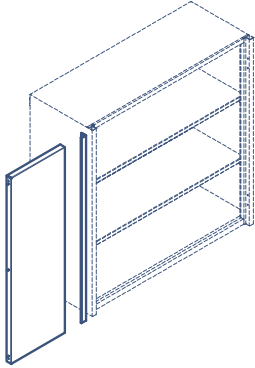

Front fillers - to cover the front space between cabinets or a cabinet and the adjacent wall

24" high wall cabinet			30" high wall cabinet		
Model no.	Width	Height	Model no.	Width	Height
WFP-1-24	1"	24"	WFP-1-30	1"	30"
WFP-6-24	6"	24"	WFP-6-30	6"	30"
WFP-12-24	12"	24"	WFP-12-30	12"	30"
WFP-24-24	24"	24"	WFP-24-30	24"	30"

36" high wall cabinet			48" high wall cabinet		
Model no.	Width	Height	Model no.	Width	Height
WFP-1-36	1"	36"	WFP-1-48	1"	48"
WFP-6-36	6"	36"	WFP-6-48	6"	48"
WFP-12-36	12"	36"	WFP-12-48	12"	48"
WFP-24-36	24"	36"	WFP-24-48	24"	48"

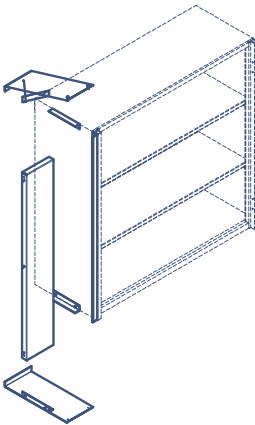

Front fillers - to cover the front, top and bottom spaces between cabinets or a cabinet and the adjacent wall

24" high wall cabinet			30" high wall cabinet		
Model no.	Width	Height	Model no.	Width	Height
WFB-6-24	6"	24"	WFB-6-30	6"	30"
WFB-12-24	12"	24"	WFB-12-30	12"	30"
WFB-24-24	24"	24"	WFB-30-30	24"	30"

36" high wall cabinet			48" high wall cabinet		
Model no.	Width	Height	Model no.	Width	Height
WFB-6-36	6"	36"	WFB-6-48	6"	48"
WFB-12-36	12"	36"	WFB-12-48	12"	48"
WFB-24-36	24"	36"	WFB-24-48	24"	48"

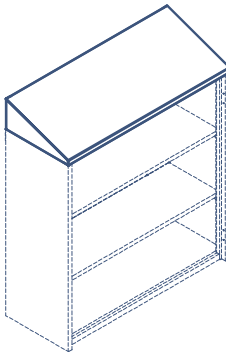

Sloping tops - to cover the wall cabinet top for housekeeping aid

14" deep wall cabinet			18" deep wall cabinet			22" deep tall cabinet		
Model no.	Width	Height	Model no.	Width	Height	Model no.	Width	Height
WST-15-14	15"	6"	WST-15-18	15"	6"	WST-15-22	15"	6"
WST-18-14	18"	6"	WST-18-18	18"	6"	WST-18-22	18"	6"
WST-21-14	21"	6"	WST-21-18	21"	6"	WST-21-22	21"	6"
WST-24-14	24"	6"	WST-24-18	24"	6"	WST-24-22	24"	6"
WST-30-14	30"	6"	WST-30-18	30"	6"	WST-30-22	30"	6"
WST-36-14	36"	6"	WST-36-18	36"	6"	WST-36-22	36"	6"
WST-42-14	42"	6"	WST-42-18	42"	6"	WST-42-22	42"	6"
WST-48-14	48"	6"	WST-48-18	48"	6"	WST-48-22	48"	6"

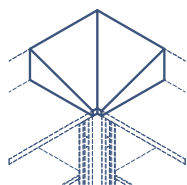

Sloping top corners - to cover the corner space between wall cabinet sloping tops

14" deep wall cabinet			18" deep wall cabinet			22" deep tall cabinet		
Model no.	Width	Height	Model no.	Width	Height	Model no.	Width	Height
WSC-14-14	15" x 15"	6"	WSC-18-18	18" x 18"	6"	WSC-22-22	22" x 22"	6"

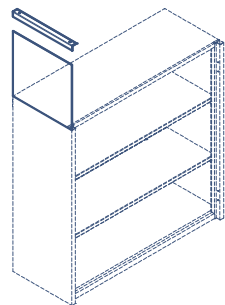

Finished end panels - to cover the space between wall cabinet top and finished ceiling

14" cabinet end panels			18" cabinet end panels			22" cabinet end panels		
Model no.	Width	Height	Model no.	Width	Height	Model no.	Width	Height
WFE-14-6	14"	6"	WFE-18-6	18"	6"	WFE-22-6	18"	6"
WFE-14-18	14"	18"	WFE-18-18	18"	18"	WFE-22-18	18"	18"
WFE-14-24	14"	24"	WFE-18-24	18"	24"	WFE-22-24	18"	24"
WFE-14-30	14"	30"	WFE-18-30	18"	30"	WFE-22-30	18"	30"

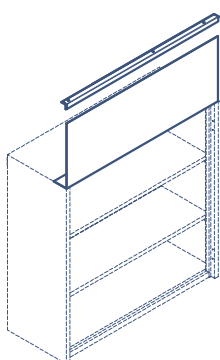

Finished front panels - to cover the space between wall cabinet top and finished ceiling

6" high front panels		18" high front panels		24" high front panels		30" high front panels	
Model no.	Width	Model no.	Width	Model no.	Width	Model no.	Width
WFF-15-6	15"	WFF-15-18	15"	WFF-15-24	15"	WFF-15-30	15"
WFF-18-6	18"	WFF-18-18	18"	WFF-18-24	18"	WFF-18-30	18"
WFF-21-6	21"	WFF-21-18	21"	WFF-21-24	21"	WFF-21-30	21"
WFF-24-6	24"	WFF-24-18	24"	WFF-24-24	24"	WFF-24-30	24"
WFF-30-6	30"	WFF-30-18	30"	WFF-30-24	30"	WFF-30-30	30"
WFF-36-6	36"	WFF-36-18	36"	WFF-36-24	36"	WFF-36-30	36"
WFF-42-6	42"	WFF-42-18	42"	WFF-42-24	42"	WFF-42-30	42"
WFF-48-6	48"	WFF-48-18	48"	WFF-48-24	48"	WFF-48-30	48"

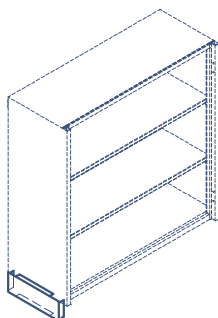

Valance end caps - to cover the space between front valance and wall

14" cabinet valance end caps			18" cabinet valance end caps		
Model no.	Width	Height	Model no.	Width	Height
WVE-14-1	12"	1"	WVE-18-1	16"	1"
WVE-14-2	12"	2"	WVE-18-2	16"	2"

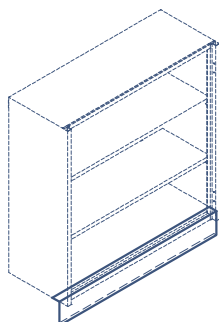

Front valance - to be installed under the wall Page 9 cabinet at 2" from the front

1" high valance			2" high valance		
Model no.	Width	Height	Model no.	Width	Height
WVF-15-1	15"	1"	WVF-15-2	15"	2"
WVF-18-1	18"	1"	WVF-18-2	18"	2"
WVF-21-1	21"	1"	WVF-21-2	21"	2"
WVF-24-1	24"	1"	WVF-24-2	24"	2"
WVF-30-1	30"	1"	WVF-30-2	30"	2"
WVF-36-1	36"	1"	WVF-36-2	36"	2"
WVF-42-1	42"	1"	WVF-42-2	42"	2"
WVF-48-1	48"	1"	WVF-48-2	48"	2"

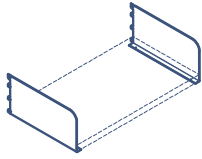

Pair of "L" shelf brackets

Model no.	Width	Depth	Height
WSB1-12	1"	12"	6"
WSB1-15	1"	15"	6"
WSB1-18	1"	18"	6"

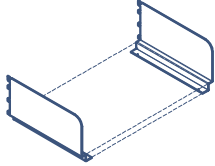

Pair of "Z" shelf brackets

Model no.	Width	Depth	Height
WSB2-6	1"	6"	6"
WSB2-9	1"	9"	6"
WSB2-12	1"	12"	6"
WSB2-15	1"	15"	6"
WSB2-18	1"	18"	6"

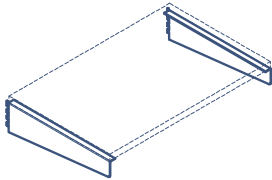

Pair of inverted "L" shelf brackets

Model no.	Width	Depth	Height
WSB3-12	1"	12"	6"
WSB3-15	1"	15"	6"
WSB3-18	1"	18"	6"

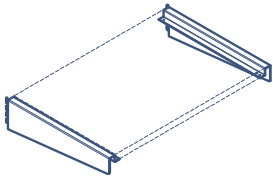

Pair of inverted "Z" shelf brackets

Model no.	Width	Depth	Height
WSB4-6	1"	6"	6"
WSB4-9	1"	9"	6"
WSB4-14	1"	12"	6"
WSB4-15	1"	15"	6"
WSB4-18	1"	18"	6"

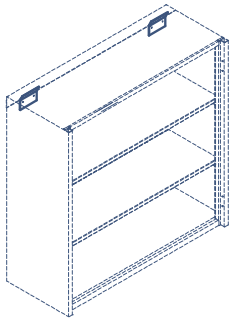

Pair of wall cabinet support brackets -for all wall cabinet sizes

Model no.	Width	Depth	Height
WCS-2	3"	3/8"	2"

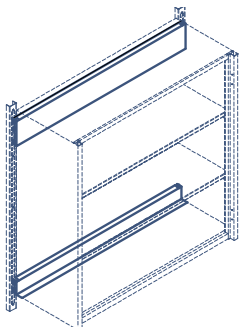

Pair of wall cabinet rail supports - fit all wall and island structures

Model no.	Width	Height
WCR-18	18"	1"
WCR-21	21"	1"
WCR-24	24"	1"
WCR-30	30"	1"
WCR-36	36"	1"
WCR-42	42"	1"
WCR-48	48"	1"
WCR-54	54"	1"
WCR-60	60"	1"

Painted steel shelves - double pan construction

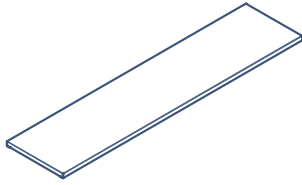

C/C width	Shelf thickness	Actual shelf width	12" depth	15" depth	18" depth
18"	1"	17 1/4"	WSH1-1812	WSH1-1815	WSH1-1818
24"	1"	23 1/4"	WSH1-2412	WSH1-2415	WSH1-2418
30"	1"	29 1/4"	WSH1-3012	WSH1-3015	WSH1-3018
36"	1"	35 1/4"	WSH1-3612	WSH1-3615	WSH1-3636
42"	1"	41 1/4"	WSH1-4212	WSH1-4215	WSH1-4242
48"	1"	47 1/4"	WSH1-4812	WSH1-4815	WSH1-4848
54"	1"	53 1/4"	WSH1-5412	WSH1-5415	WSH1-5454
60"	1"	59 1/4"	WSH1-6012	WSH1-6015	WSH1-6060

Painted steel shelves - double-pan construction with 1" high back lip

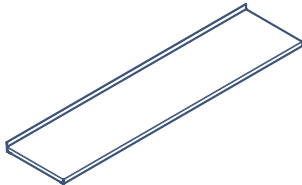

C/C width	Shelf thickness	Actual shelf width	12" depth	15" depth	18" depth
18"	1"	17 1/4"	WSH2-1812	WSH2-1815	WSH2-1818
24"	1"	23 1/4"	WSH2-2412	WSH2-2415	WSH2-2418
30"	1"	29 1/4"	WSH2-3012	WSH2-3015	WSH2-3018
36"	1"	35 1/4"	WSH2-3612	WSH2-3615	WSH2-3636
42"	1"	41 1/4"	WSH2-4212	WSH2-4215	WSH2-4242
48"	1"	47 1/4"	WSH2-4812	WSH2-4815	WSH2-4848
54"	1"	53 1/4"	WSH2-5412	WSH2-5415	WSH2-5454
60"	1"	59 1/4"	WSH2-6012	WSH2-6015	WSH2-6060

Painted steel shelves - double-pan construction with 1" high back and front lips

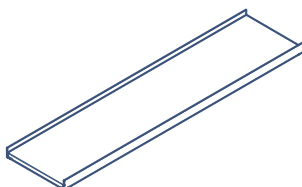

C/C width	Shelf thickness	Actual shelf width	12" depth	15" depth	18" depth
18"	1"	17 1/4"	WSH3-1812	WSH3-1815	WSH3-1818
24"	1"	23 1/4"	WSH3-2412	WSH3-2415	WSH3-2418
30"	1"	29 1/4"	WSH3-3012	WSH3-3015	WSH3-3018
36"	1"	35 1/4"	WSH3-3612	WSH3-3615	WSH3-3636
42"	1"	41 1/4"	WSH3-4212	WSH3-4215	WSH3-4242
48"	1"	47 1/4"	WSH3-4812	WSH3-4815	WSH3-4848
54"	1"	53 1/4"	WSH3-5412	WSH3-5415	WSH3-5454
60"	1"	59 1/4"	WSH3-6012	WSH3-6015	WSH3-6060

Front retaining rods with shelf brackets

- between a pair of shelf supports using 3/8" type 304 stainless steel rods

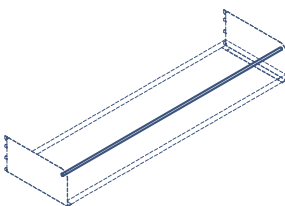

Model no.	C/C width	Rod size	Rod height	Qty of rods/kit
FRD-18	18"	3/8" diam.	2"	1
FRD-24	24"	3/8" diam.	2"	1
FRD-30	30"	3/8" diam.	2"	1
FRD-36	36"	3/8" diam.	2"	1
FRD-42	42"	3/8" diam.	2"	1
FRD-48	48"	3/8" diam.	2"	1

Reagent rack assemblies – all welded assembly with 4-legs, “U” fixing brackets and 1 ½” rails

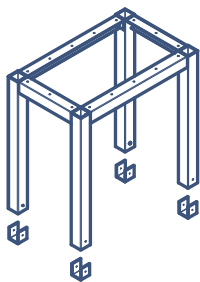

11" high racks			17" high racks		
Width	1 1" depth	15" depth	Width	1 1" depth	15" depth
18"	RR1-11-1811	RR1-11-1815	18"	RR1-17-1811	RR1-17-1815
24"	RR1-11-2411	RR1-11-2415	24"	RR1-17-2411	RR1-17-2415
30"	RR1-11-3011	RR1-11-3015	30"	RR1-17-3011	RR1-17-3015
36"	RR1-11-3611	RR1-11-3615	36"	RR1-17-3611	RR1-17-3615
42"	RR1-11-4211	RR1-11-4215	42"	RR1-17-4211	RR1-17-4215
48"	RR1-11-4811	RR1-11-4815	48"	RR1-17-4811	RR1-17-4815
54"	RR1-11-5411	RR1-11-5415	54"	RR1-17-5411	RR1-17-5415
60"	RR1-11-6011	RR1-11-6015	60"	RR1-17-6011	RR1-17-6015

Add-on reagent rack assemblies – all welded assembly with 2-legs, “U” fixing brackets and 1 ½” rails and 1 ½” rails

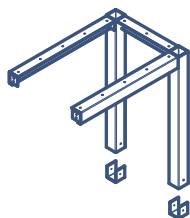

11" high racks			17" high racks		
Width	1 1" depth	15" depth	Width	1 1" depth	15" depth
18"	RR2-11-1811	RR2-11-1815	18"	RR2-17-1811	RR2-17-1815
24"	RR2-11-2411	RR2-11-2415	24"	RR2-17-2411	RR2-17-2415
30"	RR2-11-3011	RR2-11-3015	30"	RR2-17-3011	RR2-17-3015
36"	RR2-11-3611	RR2-11-3615	36"	RR2-17-3611	RR2-17-3615
42"	RR2-11-4211	RR2-11-4215	42"	RR2-17-4211	RR2-17-4215
48"	RR2-11-4811	RR2-11-4815	48"	RR2-17-4811	RR2-17-4815
54"	RR2-11-5411	RR2-11-5415	54"	RR2-17-5411	RR2-17-5415
60"	RR2-11-6011	RR2-11-6015	60"	RR2-17-6011	RR2-17-6015

Reagent rack assemblies – all welded assembly with 4-legs, “U” fixing brackets and 4” rails

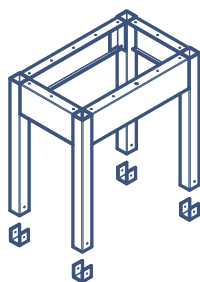

11" high racks			17" high racks		
Width	1 1" depth	15" depth	Width	1 1" depth	15" depth
18"	RR3-11-1811	RR3-11-1815	18"	RR3-17-1811	RR3-17-1815
24"	RR3-11-2411	RR3-11-2415	24"	RR3-17-2411	RR3-17-2415
30"	RR3-11-3011	RR3-11-3015	30"	RR3-17-3011	RR3-17-3015
36"	RR3-11-3611	RR3-11-3615	36"	RR3-17-3611	RR3-17-3615
42"	RR3-11-4211	RR3-11-4215	42"	RR3-17-4211	RR3-17-4215
48"	RR3-11-4811	RR3-11-4815	48"	RR3-17-4811	RR3-17-4815
54"	RR3-11-5411	RR3-11-5415	54"	RR3-17-5411	RR3-17-5415
60"	RR3-11-6011	RR3-11-6015	60"	RR3-17-6011	RR3-17-6015

Add-on reagent rack assemblies – all welded assembly with 2-legs, “U” fixing brackets and 4” rails

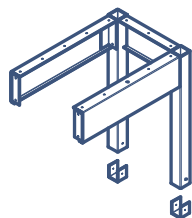

11" high racks			17" high racks		
Width	1 1" depth	15" depth	Width	1 1" depth	15" depth
18"	RR4-11-1811	RR4-11-1815	18"	RR4-17-1811	RR4-17-1815
24"	RR4-11-2411	RR4-11-2415	24"	RR4-17-2411	RR4-17-2415
30"	RR4-11-3011	RR4-11-3015	30"	RR4-17-3011	RR4-17-3015
36"	RR4-11-3611	RR4-11-3615	36"	RR4-17-3611	RR4-17-3615
42"	RR4-11-4211	RR4-11-4215	42"	RR4-17-4211	RR4-17-4215
48"	RR4-11-4811	RR4-11-4815	48"	RR4-17-4811	RR4-17-4815
54"	RR4-11-5411	RR4-11-5415	54"	RR4-17-5411	RR4-17-5415
60"	RR4-11-6011	RR4-11-6015	60"	RR4-17-6011	RR4-17-6015

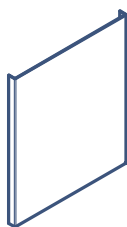

Reagent rack end closure panels

Model no.	Width	Depth	Height
RR5-11	11"	1"	11"
RR5-17	15"	1"	17"

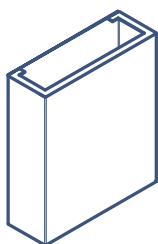

Reagent rack service boxes - with side access panel

Model no.	Width	Depth	Height
RR6-1111	11"	6"	11"
RR6-1511	15"	6"	11"
RR6-1117	11"	6"	17"
RR6-1517	15"	6"	17"

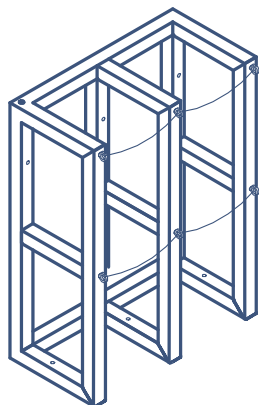

Single cylinder storage racks - all welded assembly using 2" tubing

Model no.	Width	Depth	Height	Cylinder capacity 10" diameter max
CSR-11	16"	16"	30"	1 cylinder
CSR-12	30"	16"	30"	2 cylinders
CSR-13	44"	16"	30"	3 cylinders
CSR-14	58"	16"	30"	4 cylinders

Sink plated 1/2" eye-bolts and chains with snap hook at one end.

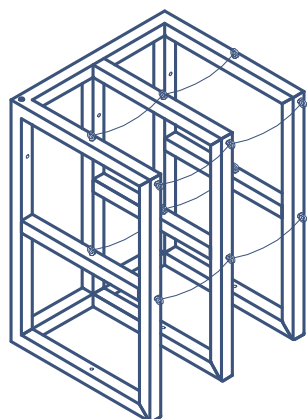

Double cylinder storage racks - all welded assembly using 2" tubing

Model no.	Width	Depth	Height	Cylinder capacity 10" diameter max
CSR-21	16"	26"	30"	2 cylinders
CSR-22	30"	26"	30"	4 cylinders
CSR-23	44"	26"	30"	6 cylinders
CSR-24	58"	26"	30"	8 cylinders

Sink plated 1/2" eye-bolts and chains with snap hook at one end.

Umbilical chases

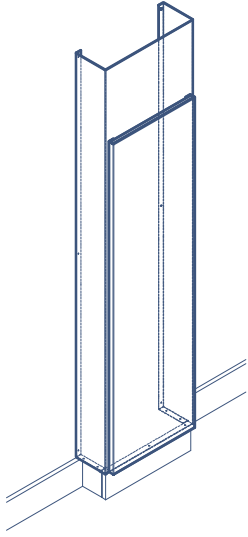

Wall bench chases - with a front access panel

60" high chases				72" high chases			
Width	6" depth	8" depth	10" depth	Width	6" depth	8" depth	10" depth
12"	UC1-1206	UC1-1208	UC1-1210	12"	UC2-1206	UC2-1208	UC2-1210
18"	UC1-1806	UC1-1808	UC1-1810	18"	UC2-1806	UC2-1808	UC2-1810
24"	UC1-2406	UC1-2408	UC1-2410	24"	UC2-2406	UC2-2408	UC2-2410

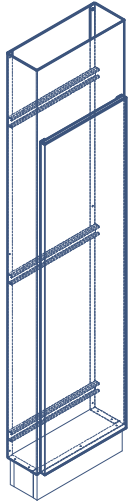

Island bench chases - with 3 welded horizontal struts and a one-side access panel

60" high chases				72" high chases			
Width	6" depth	8" depth	10" depth	Width	6" depth	8" depth	10" depth
12"	UC3-1206	UC3-1208	UC3-1210	12"	UC4-1206	UC4-1208	UC4-1210
18"	UC3-1806	UC3-1808	UC3-1810	18"	UC4-1806	UC4-1808	UC4-1810
24"	UC3-2406	UC3-2408	UC3-2410	24"	UC4-2406	UC4-2408	UC4-2410

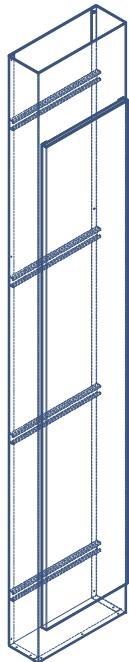

Independent floor to ceiling chases - with 4 welded horizontal struts and a one-side access panel

96" high chases				108" high chases			
Width	6" depth	8" depth	10" depth	Width	6" depth	8" depth	10" depth
12"	UC5-1206	UC5-1208	UC5-1210	12"	UC6-1206	UC6-1208	UC6-1210
18"	UC5-1806	UC5-1808	UC5-1810	18"	UC6-1806	UC6-1808	UC6-1810
24"	UC5-2406	UC5-2408	UC5-2410	24"	UC6-2406	UC6-2408	UC6-2410

Overhead service carrier that can integrates plumbing, electrical and data services and local exhaust arm connection upon the customer requirements.

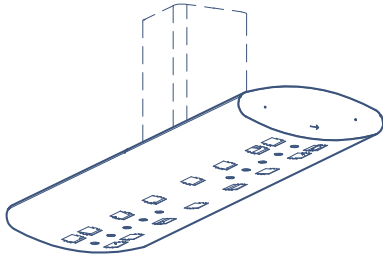

Overhead service carrier horizontal frames with finished ends - 24" x 8" oval shape carrier

Model no.	Height	Depth	Width
OSC1-36	8"	24"	36"
OSC1-48	8"	24"	48"
OSC1-60	8"	24"	60"
OSC1-72	8"	24"	72"

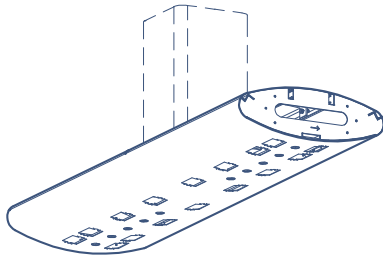

Overhead service carrier horizontal frames with no finished ends - 24" x 8" oval shape carrier

Model no.	Height	Depth	Width
OSC2-36	8"	24"	36"
OSC2-48	8"	24"	48"
OSC2-60	8"	24"	60"
OSC2-72	8"	24"	72"

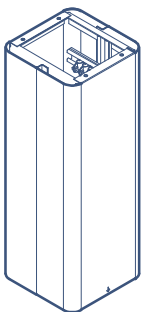

Overhead service carrier vertical chases - 12" x 12"

Model no.	Height	Depth	Width
OSC3-22	22"	12"	12"
OSC3-34	34"	12"	12"
OSC3-46	46"	12"	12"



BEDCOLAB LTD

**2305, Francis-Hugues Avenue
Laval, Quebec, Canada H7S 1N5**

Phone: 514.384.2820 / 1.800.461.6414

Fax: 514.384.9210

E-mail: information@bedcolab.com

Web Site: www.bedcolab.com



Authorized dealer: